

SERVICE MANUAL

DIGITALLY QUARTZ LOCKED TUNER

SANSUI TU-919

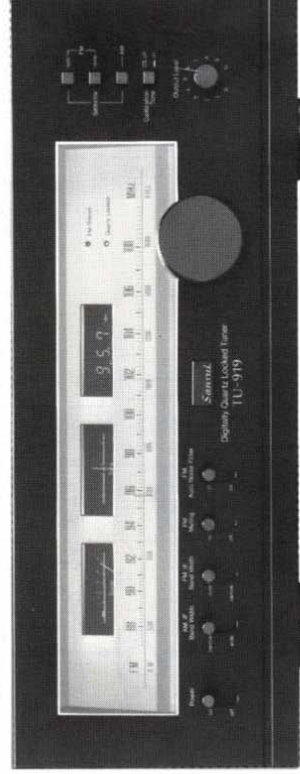

SPECIFICATIONS

FM Section

Tuning range 88 to 108 MHz
Usable sensitivity
Mono IHF 9.0 dBf (1.54 μ V; T100)

DIN 0.95 μ V
Stereo IHF 15.0 dBf

50 dB quieting sensitivity

Mono 12.5 dBf
Stereo 34.0 dBf

Signal to noise ratio at 65 dBf

Mono 82 dB
Stereo 76 dB

Distortion at 65 dBf (WIDE)

Mono less than 0.06 % at 100 Hz
less than 0.04 % at 1,000 Hz
less than 0.08 % at 6,000 Hz
Stereo less than 0.09 % at 100 Hz
less than 0.06 % at 1,000 Hz
less than 0.15 % at 6,000 Hz

Alternate channel selectivity (at 400 kHz)

WIDE 50 dB

NARROW 80 dB

Capture ratio 0.9 dB

Image response ratio . . . 110 dB (at 98 MHz)

Spurious response ratio

. 110 dB (at 98 MHz)

Stereo separation 40 dB at 100 Hz

50 dB at 1,000 Hz

35 dB at 10,000 Hz

30 to 15,000 Hz

Frequency response . . . +0.2 dB, -0.5 dB

Antenna input impedance

. 300 ohms balanced
75 ohms unbalanced

AM Section

Tuning range 530 to 1,600 kHz

Usable sensitivity (Bar antenna)

. 47 dB/m (220 μ V/m)

Selectivity 35 dB

Signal to noise ratio . . . 50 dB

Others

Output voltage and impedance

OUTPUT 0 to 1.0 V/2.5 kilohms

DOLBY FM 200 mV/9 kilohms

Power requirements . . . 100, 120, 220, 240 V 50/60 Hz

For U.S.A. and Canada

. 120 V (60 Hz)

Power consumption . . . 22 W

Dimensions

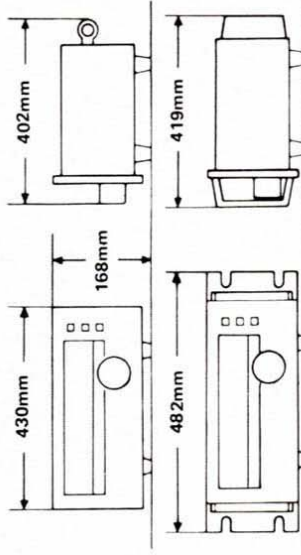

Weight 9.8 kg (21.6 lbs) net
11.6 kg (25.6 lbs) packed

Sansui

SANSUI ELECTRIC CO., LTD.

* Design and specifications subject to changes without notice for improvements.

* In order to simplify the explanation illustrations may sometimes differ from the originals.

1. BLOCK DIAGRAM

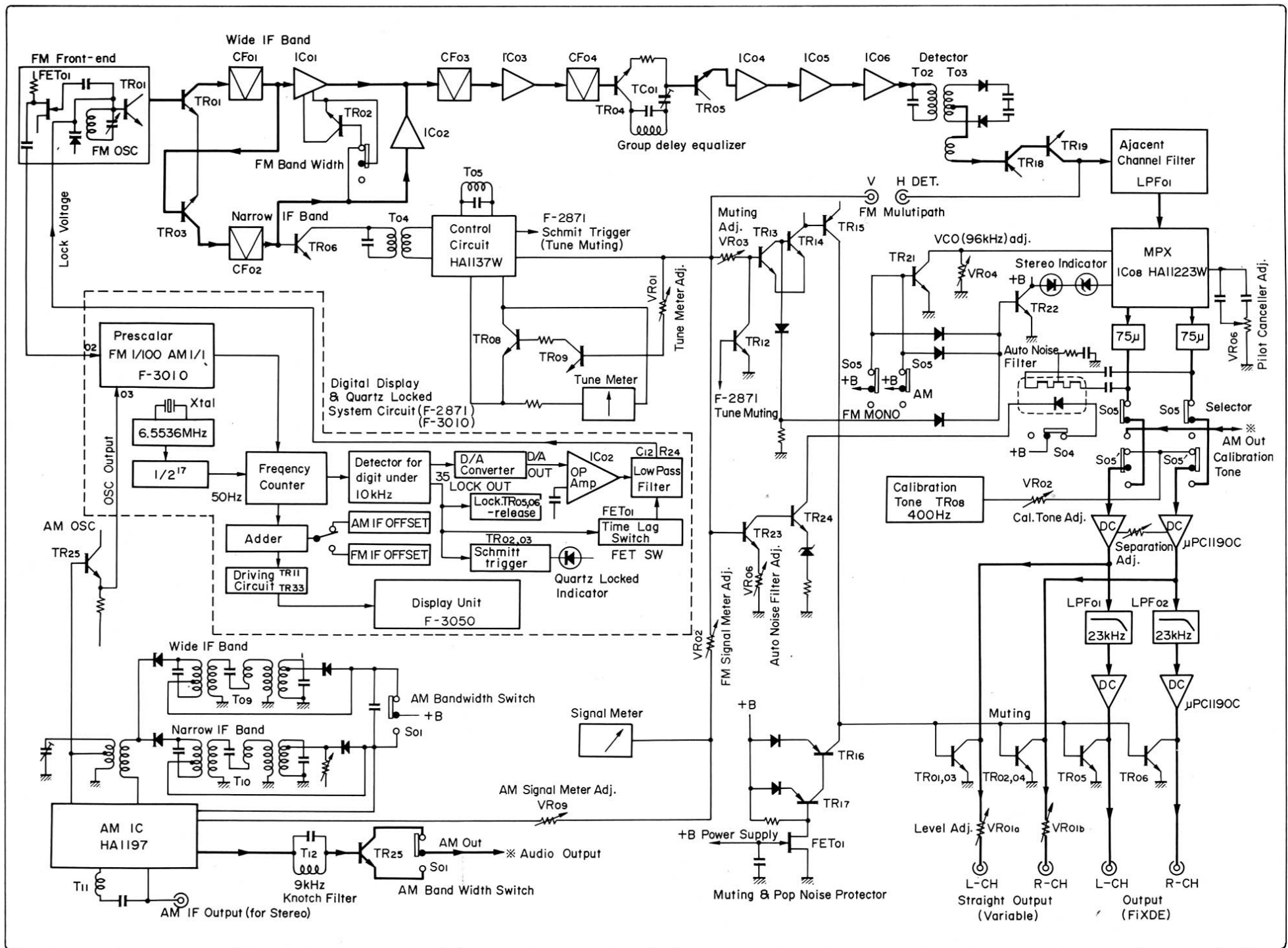

2. ADJUSTMENTS

1) FM, IF, RF Adjustment Calibration(See Top View on Page 8)

- Note: 1. Selector FM MONO
 2. Output Level Volume MAX.

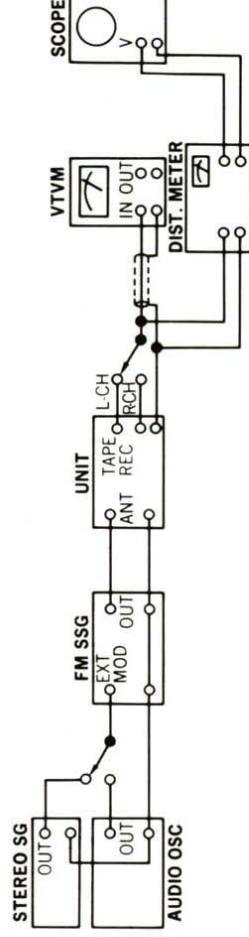

STEP	SUBJECT	FEED SIGNAL		MEASURE OUTPUT	ADJUST	ADJUST FOR	REMARKS
		FROM	TO				
1.	Confirm Locked Indicator	98 MHz ANT Input 65 dBf (59.8 dB) 1 kHz (100% MOD) FM SSG	ANT terminal 300Ω	Locked Indicator		Indicator Lighting	Tune 98 MHz at Display Unit
2.	IF Coil Adj.	98 MHz ANT Input 20 ~ 30 dBf (14.8 ~ 24.8 dB) 1 kHz (100% MOD) FM SSG	Same as above	Signal Meter	T02 (Front-end) T04 (F-2870)	Max. Output	
3.	Tune Meter	98 MHz ANT Input 65 dBf (59.8 dB) 1 kHz (100% MOD)	Same as above	Tune Meter	T05 (F-2870)	Center on Meter	
		No Input		Tune Meter	VR01 (F-2870)	By the noise between FM station, make the motor indication not swinging	
4.	Discriminator Coil Adj.	98 MHz ANT Input 65 dBf (59.8 dB) 1 kHz (100% MOD)	Same as above	TP01 (F-2870) DC Volt Meter	T03 (F-2870)	0 ~ 0.03V	
5.	AFC Voltage Adj.	Receive the nearest FM station		TP02 (F-2871) DC Volt Meter	V01 (F-2871)	DC 7V	Ground TP03 (F-2871)
6.	Distortion Adj.	98 MHz ANT Input 65 dBf (59.8 dB) 1 kHz (100% MOD)	Same as above	Out R or L-CH Distortion Meter	T02, T01, TC01 (F-2870)	Min. Distortion	
7.	98 MHz Dial Calibration	No Input		Dial Pointer	Tuning Knob	98 MHz	Confirm the dial calibration on the frequencies of 90 MHz & 106 MHz Ground TP03 (F-2871)
		Same as above		Indication of Display Unit	TC05 (Front-end)	98 MHz	
8.	98 MHz RF Adj.	98 MHz ANT Input Minimum value with sine wave 1000 Hz (100% MOD) FM SSG	ANT terminal 300Ω	Out R or L-CH Scope & VTVM	TC01, TC02 TC03, TC04 (Front-end)	Max. Output	Muting Switch . . . OFF
9.	Signal Meter Adj.	98 MHz ANT Input 100 dBf (94.8 dB) 1 kHz (100% MOD)	Same as above	Signal Meter	VR02 (F-2870)	4.7 on Meter	

● Abbreviations

Equipment

AM FM Generator Oscilloscope Genescope
 AM Standard Signal Generator AM SSG
 FM Standard Signal Generator FM SSG
 FM Stereo Generator Stereo SG
 Oscilloscope Scope
 Audio Oscillator Audio Osc.
 Distortion Meter Dist. Meter

Others

Antenna ANT.
 Modulation MOD.
 Total Harmonic Distortion T.H.D.

2) FM Stereo Adjustment (See Top View on Page 8)

- Note: 1. Selector FM Auto
 2. Output Level Volume MAX.

STEP	SUBJECT	FEED SIGNAL		MEASURE OUTPUT	ADJUST	ADJUST FOR	REMARKS
		FROM	TO				
1.	PLL VCO Adj.	98 MHz ANT Input 65 dBf (59.8 dB) FM SSG Pilot 19 kHz (9% MOD) R or L MODE 1 kHz + Pilot (100% MOD) STEREO SG	ANT terminal 300Ω	Stereo Indicator	VR04 F-2870	Light Indicator	Adjust the VR04 within center of lighting level
		98 MHz ANT Input 65 dBf (59.8 dB) FM SSG (No MOD)	Same as above	TP02 F-2870 Freq. Counter	VR04 F-2870	76 kHz ±200 kHz	
2.	Distortion In case of STEREO	98 MHz ANT Input 65 dBf (59.8 dB) FM SSG Pilot 19 kHz (9% MOD) L-CH MODE 100 Hz + Pilot (100% MOD) STEREO SG	Same as above	OUT L-CH Dist. Meter	T06 F-2870	Min. Distortion	
		98 MHz ANT Input 65 dBf (59.8 dB) FM SSG Pilot 19 kHz (9% MOD)	Same as above	OUT L or R-CH VTVM	VR05 F-2870	Min. Distortion	VR05 Pilot Canceller Volume
3.	Separation	98 MHz ANT Input 65 dBf (59.8 dB) FM SSG Pilot 19 kHz (9% MOD) R MODE 1 kHz + Pilot (100% MOD) STEREO SG	Same as above	OUT L or R-CH Dist. Meter	T01 Front-end TC01 F-2870 VR05 F-2870	Min. Distortion	
		98 MHz ANT Input 65 dBf (59.8 dB) FM SSG Pilot 19 kHz (9% MOD) L or R-CH MODE 1 kHz + Pilot (100% MOD) STEREO SG	Same as above	OUT L-CH VTVM	VR01 F-2875	OUT -45 dB	Confirm L-CH → R-CH
4.	Muting Level & Indicator Level	98 MHz ANT Input 15 dBf (9.8 dB) FM SSG Pilot 19 kHz (9% MOD) L or R MODE 1 kHz + Pilot (100% MOD) STEREO SG	Same as above	Stereo Indicator Out L or R-CH VTVM	VR03 F-2870	Muting & Indicator Level 15 dBf (9.8 dB)	
		98 MHz ANT Input 45 dBf (39.8 dB) FM SSG Pilot 19 kHz (9% MOD) Main 10 kHz + Pilot (100% MOD) STEREO SG	Same as above	OUT L or R-CH VTVM		Set indication level of VTVM to 0 dB	Auto Noise Filter Switch . . . OFF
5.	Auto Noise Filter Adj.	Same as above	Same as above		VR06 F-2870	Set indication level to -3 dB from the above level	Auto Noise Filter Switch . . . ON
		98 MHz ANT Input 65 dBf (59.8 dB) 1 kHz (MONO 100%)	Same as above	OUT L or R-CH VTVM		Set indication level of VTVM to 0 dB	Calibration Switch . . . OFF
6.	Calibration Level Adj.	No Input		OUT L or R-CH VTVM	VR02 F-2875	Set indication level to -5 dB from the above level	Calibration Switch . . . ON

3) AM, IF Adjustment & Dial Calibration (See Top View on Page 8)

- Note: 1. Selector AM
 2. Output Level Volume MAX.

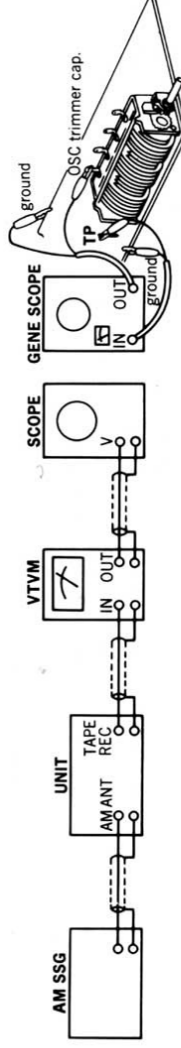

STEP	SUBJECT	FEED SIGNAL		MEASURE OUTPUT	ADJUST	ADJUST FOR	REMARKS
		FROM	TO				
1.	IF Coil Adj. (Narrow Position)	Genescope Output 50 dB	TP03 (F-2870)	TP04 (F-2870)	T09, T11 (F-2870)	Max. Output	
2.	IF Coil Adj. (Wide Position)	Same as above	Same as above	Same as above	T10 (F-2870)	Max. Output	
3.	600 kHz Dial Calibration	No Input		Dial Pointer	Tuning Knob	600 kHz	
		Same as above		Indication of Digital Display Unit	T07 (F-2870)	600 kHz	
4.	1400 kHz Dial Calibration	Same as above		Dial Pointer	Tuning Knob	1400 kHz	
		Same as above		Indication of Digital Display Unit	AM2 (Front-end)	1400 kHz	
5.	600 kHz RF Adj.	600 kHz ANT Input 50 dB 400 Hz (30% MOD) / AM SSG	AM Antenna Terminal	Out R or L-CH Scope & VTVM	T701 (Bar Antenna) T08, L10 (F-2870)	Max. Output	
6.	1400 kHz RF Adj.	Same as above	Same as above	Same as above	AM1, AM3 (Front-end)	Max. Output	
7.	Signal Meter Adj. (Narrow Position)	1000 kHz ANT Input 100 dB 400 Hz (100% MOD)	Same as above	Signal Meter	VR08 (F-2870)	4.7 on Meter	
		Same as above	Same as above	Signal Meter	VR07 (F-2870)	4.7 on Meter	
8.	9 kHz Knotch filter Adj.	9 kHz 5 mV Audio OSC.	TP04 (F-2870)	Out R or L-CH VTVM	T12 (F-2870)	Min. Output	

●NEW MEASUREMENT FOR FM.

Input signal level under the provision of IHFM-T-200, a new measurement method is indicated by available power ratio "dBf". To obtain approximate available power ratio "dBf", abstract 0.8 from attenuator indication of general FMSG (open load indication type); however, the former measurement, IHFM-T-100 is designated together too.

The way of modulation on IHFM-T-200 is shown below.

	modulation frequency	modulation mode	modulation factor
FM MONO	1000 Hz		100%
FM STEREO	1000 Hz	SUB	Pilot 9% Pilot + SUB 100%

- The relation between the standard input 65 dBf of IHFM-T-200 and the former indication "dB" is shown below.

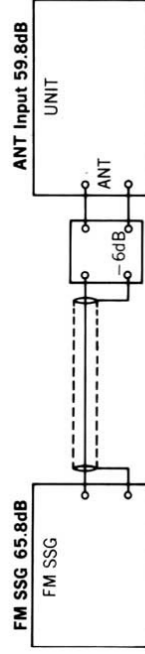

Selection of Intermediate Frequency for FM & AM

The digital locking point differs with frequency rank of FM ceramic filter (CF01 ~ 04) and AM IF LC Filter used in F-2870, therefore, it is neces to change inserting position of diodes and jumper wires (digital locking point) by frequency rank of using filter. When re- placement, play.

Col- ouring of CF01 ~ CF04	Intermediate Frequency	Connecting Position on F-2871					
		FM C	AM Z	FM B	AM Y	FM A	AM X
Black	10.64 MHz	D	-	D	-	-	-
Brown	10.66 MHz	-	-	-	-	-	-
Blue	10.68 MHz	D	-	J	-	-	-
Red	10.70 MHz	-	-	-	-	D	D
Orange	10.72 MHz	D	-	-	-	D	D
Gray	10.74 MHz	-	-	-	-	D	D
White	10.76 MHz	D	-	-	-	-	-
Intermediate of T09, T10 (kHz)		450	455	450	455	450	455

Note: D . . . Diode J . . . Jumper - . . . Open

EX. The connection when using ceramic filter with frequency rank blue (10.68 MHz) for CF01 ~ CF04 and 455 kHz filter for TR09 & TR10, is as shown as Fig. in the right.

Stock No. of T09, T10

	450 kHz	455 kHz
T09	0910490	4230580
T10	0910500	4230690

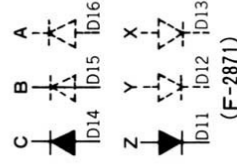

3. PARTS LOCATION & PARTS LIST

3-1. F-2870 Tuner Circuit Board (Stock No. 7522251)

Conductor Side

Since some of capacitors and resistors are omitted from parts lists in this Service Manual, refer to the Common Parts List for capacitors & resistors which was appended previously to each Sansui Manual.

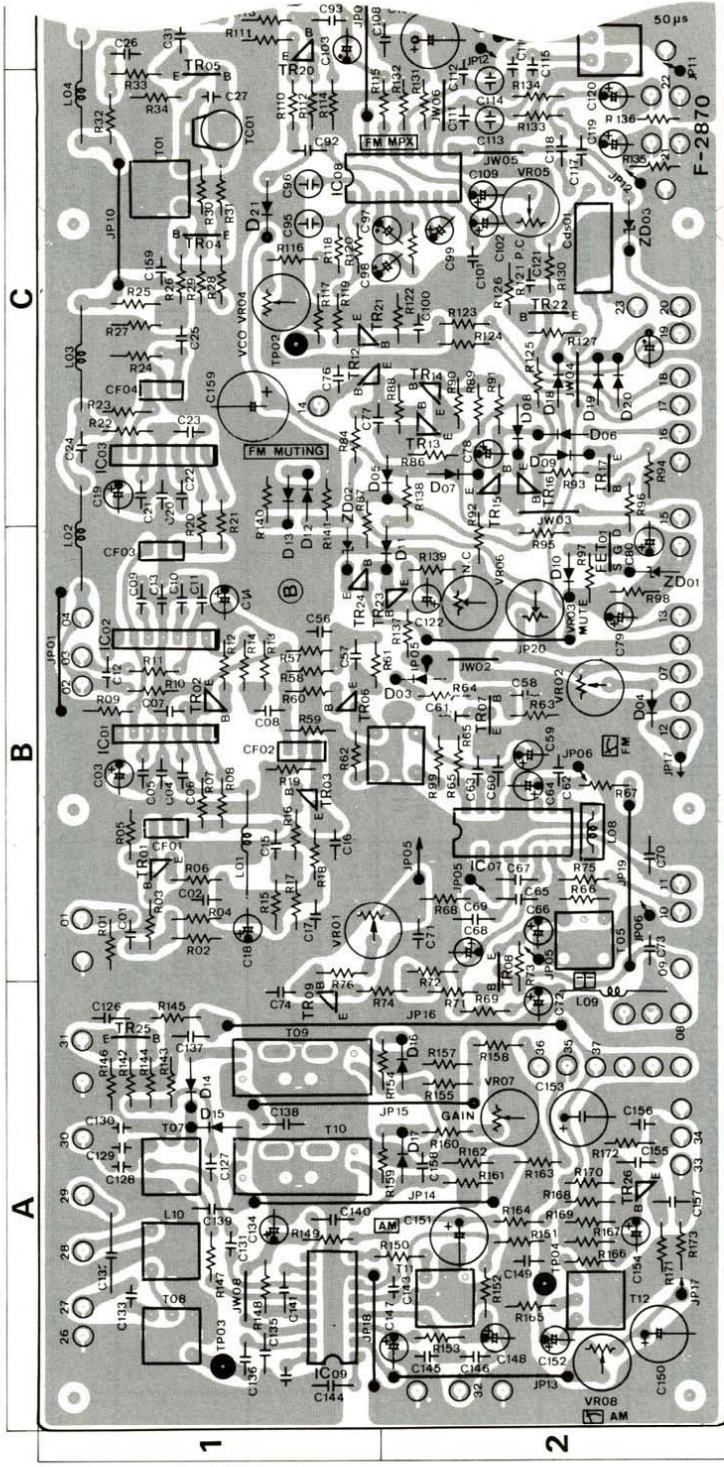

Parts List

Parts No.	Stock No.	Description	Position	Parts No.	Stock No.	Description	Position	Parts No.	Stock No.	Description	Position
•Transistor											
TR01	0306340 ~ 2	2SC1674 M, L, K	1B	D 05	0311160	IS2473D	2C	T 01	4236130	FM IF Coil 10.7 MHz	1C
TR02	0305731 ~ 3	2SC711 E, F, G	1B	D 06	0311180	IS1588	2C	T 02	4236010	FM IF Coil 10.7 MHz	2D
TR03	0305951 ~ 3	2SC945 O, P, K	1B	D 07	0311160	IS2473D	2C	T 03	4236020	FM IF Coil 10.7 MHz	2D
TR04	0306340 ~ 2	2SC1674 M, L, K	1C	D 08	0340170	MV-103	2C	T 04	4236930	FM IF Coil 10.7 MHz	2B
TR05	0306340 ~ 2	2SC1674 M, L, K	1C	D 09	0311160	IS2473D	2C	T 05	4236940	FM IF Coil 10.7 MHz	2B
TR06	0306340 ~ 2	2SC1674 M, L, K	1B	D 10	0311160	IS1588	2C	T 06	4240720-1	MPX Coil 19 kHz	1D
TR07	0306340 ~ 2	2SC1674 M, L, K	2B	D 11	0311160	IS1588	2B	T 07	4228710	OSC Coil	1A
TR08	0306300, 1	2SC1636-1, 2	2B	D 12	0311180	IS1588	2B	T 08	4210400	AMI RF Coil	1A
TR09	0305731 ~ 3	2SC711 E, F, G	1A	D 13	0340150	MV-12	1C	T 09	4230680	AMI IF Coil 455 kHz	1A
TR12	0305731 ~ 3	2SC711 E, F, G	1C	D 14	0311160	IS2473D	1C	T 10	4230690	AMI IF Coil 455 kHz	1A
TR13	0305951 ~ 3	2SC945 O, P, K	2C	D 15	0311180	IS1588	2C	T 11	4230620	AMI IF Coil 455 kHz	2A
TR14	0305951 ~ 3	2SC945 O, P, K	2C	D 16	0311160	IS2473D	2C	T 12	0910450	Filter Coil	2A
TR15	0300510, 1	2SA733A (P), (O)	2C	D 17	0311160	IS2473D	2C	LF 01	0910400	Adjacent Channel Filter	2D
TR16	0300510, 1	2SA733A (P), (O)	2C	D 18	0311160	IS1588	1A	VR01	1035190	100kΩ B Tune Meter Volume	1B
TR17	0300510, 1	2SA733A (P), (O)	2C	D 19	0311160	IS1588	2A	VR02	1035130	10kΩ B FM Signal Meter Volume	2B
TR18	0300510, 1	2SA733A (P), (O)	2C	D 20	0311180	IS1588	2A	VR03	1035190	100kΩ B Muting Volume	2B
TR19	0306070, 1	2SC1313 F, G	2D	D 21	0310340	10D1	2A	VR04	1034230	2.2kΩ B MPX VCO Volume	2C
TR20	0305731 ~ 3	2SC711 E, F, G	1D				2C	VR05	1035170	47kΩ Pilot Canceller Volume	2C
TR21	0305731 ~ 3	2SC711 E, F, G	1C				2C	VR06	1035110	4.7kΩ B Auto Noise Filter Volume	2B
TR22	0305951 ~ 3	2SC945 O, P, K	2C				2C	VR07	1035150	22kΩ B AM Width Volume	2A
TR23	0305951 ~ 3	2SC945 O, P, K	1B				2C	VR08	1035070	1kΩ B AM Signal Meter Volume	2A
TR24	0305731 ~ 3	2SC711 E, F, G	1B				2C	TC 01	1230090	Trimmer	1C
TR25	0305951 ~ 2	2SC945 O, P, K	1A				2C	CD 01	0920080	Photo-coupler Ceramic Filter Assy (CF01 ~ CF04)	1B, C
TR26	0305731 ~ 3	2SC711 E, F, G	2A				2C	S 01	1110240	De-emphasis Switch	
	0305951 ~ 3	2SC945 O, P, K	2A				2C				
•IC											
IC 01	0360590	TA7302P	1B	C 86	0623120	12pF 125V P.C.	2B				
IC 02	0360590	TA7302P	1B	C 91	0622221	220pF 125V P.C.	2D				
IC 03	0360590	TA7302P	1C	C 94	6800pF 50V P.C.	6800pF 50V P.C.	1D				
IC 04	9360590	TA7302P	1D	C 95	0622102	1000pF 125V P.C.	1C				
IC 05	0360270	IC μPC577H	1D	C 96	0622102	2200pF 125V P.C.	1C				
IC 06	03600540	UPC 1163H	1D	C 97	0573478	0.47μF 35V Ta.C.	1C				
IC 07	03600350	HA1137W	2B	C 98	3.3μF 35V Ta.C.	3.3μF 35V Ta.C.	2C				
IC 08	03600680	HA11223W	2C	C 99	3.3μF 35V Ta.C.	3.3μF 35V Ta.C.	2C				
IC 09	0360380	HA1197	1A	C 102	0573338	0.33μF 35V Ta.C.	2C				
				C 109	0573338	0.33μF 35V Ta.C.	2C				
				C 128	0669210	10pF 50V C.C.	1A				
				C 129	0622391	390pF 125V P.C.	1A				
				C 130	0669406	22pF 50V C.C.	1A				
				C 132	0679002	0.56pF 500V G.C.	1A				
•Diode											
D 01	0311160	IS2473D	2D	L 01 ~ 06	4290011	3.5μH Choke Coil	1B, C, D				
D 02	0340170	MV 103	2D	L 07	4900400	100μH Inductor	2D				
D 03	0311160	IS2473D	2B	L 08	4290300	18μH Inductor	2B				
D 04	0311180	IS1588	2B	L 09	4290011	3.5μH Inductor	2A				
				L 10	4290350	240μH Choke Coil	1A				

3-2. F-3010 Pre-Scaler Circuit Board (Stock No. 7597931)

Conductor Side

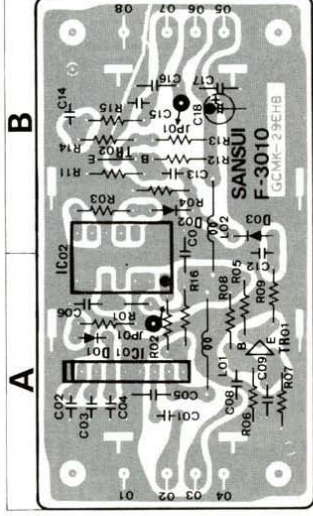

Parts List

Parts No.	Stock No.	Description	Position
● Transistor			
TR01	0306341, 2	2SC1674 L, K	A
TR02	0306341, 2	2SC1674 L, K	B
● IC			
IC 01	0361130	AN6821	A
IC 02	0361120	SN74LS00N	A
● Diode			
D 01	0311160	1S2473D	A
D 02	0311160	1S2473D	B
D 03	0311160	1S2473D	B
● Inductor			
L 01	4290011	3.5μH Choke Coil	A
L 02	4290011	3.5μH Choke Coil	B

3-3. F-2871 Digitally Display Circuit Board (Stock No. 7597871)

Conductor Side

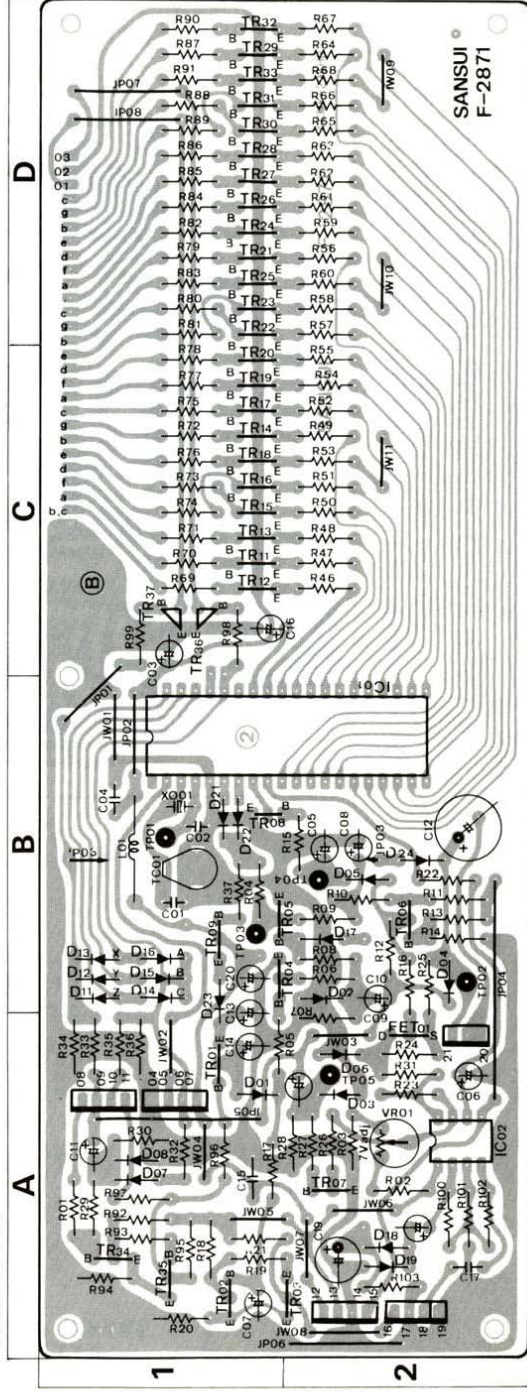

Parts List

Parts No.	Stock No.	Description	Position	Parts No.	Stock No.	Description	Position
● Transistor							
TR01	0300510 ~ 2	2S4733A P, O, R	1A	IC 01	0360910	M5M540FRS	1, 2B
TR02	0305951 ~ 3	2SC945 Q, P, K	1A	IC 02	0360770	NJM4588D	2A
TR03	0305951 ~ 3	2SC945 Q, P, K	2A	● FET			
TR04	0305951 ~ 3	2SC945 Q, P, K	1B	FET01	{0370300 ~ 3	2SK117, O, Y, GR, BL	2A
TR05	0305951 ~ 3	2SC945 Q, P, K	1B	FET01	{0370340 ~ 7	2SK163-K1, K2, L1, L2, M1, M2, N1, N2	2A
TR06	0305951 ~ 3	2SC945 Q, P, K	2B	● Diode			
TR07	0305951 ~ 3	2SC945 Q, P, K	2A	D 01 ~ 24	0311160	1S2473D	1A, B, 2A, B
TR08	0305951 ~ 3	2SC945 Q, P, K	1B	C 01	0669508	8pF 50V C.C.	1B
TR09	0305951 ~ 3	2SC945 Q, P, K	1B	C 02	0661220	22pF 50V C.C.	1B
TR10	0305951 ~ 3	2SC945 Q, P, K	1C	L 01	4290011	Choke Coil 3.5μH	1B
TR11	0305951 ~ 3	2SC945 Q, P, K	1C	VR01	1035110	4.7kΩ AFC Bias Volume	2A
TR12	0305951 ~ 3	2SC945 Q, P, K	1C	TC01	1230150	30pF Trimmer Capacitor	1B
TR13	0305951 ~ 3	2SC945 Q, P, K	1C	X001	0930040	Xtal 6.5536 MHz	1B
TR14	0305951 ~ 3	2SC945 Q, P, K	1C				
TR15	0305951 ~ 3	2SC945 Q, P, K	1C				
TR16	0305951 ~ 3	2SC945 Q, P, K	1C				
TR17	0305951 ~ 3	2SC945 Q, P, K	1C				
TR18	0305951 ~ 3	2SC945 Q, P, K	1C				
TR19	0305951 ~ 3	2SC945 Q, P, K	1C				
TR20	0305951 ~ 3	2SC945 Q, P, K	1C				
TR21	0305951 ~ 3	2SC945 Q, P, K	1D				
TR22	0305951 ~ 3	2SC945 Q, P, K	1D				
TR23	0305951 ~ 3	2SC945 Q, P, K	1D				
TR24	0305951 ~ 3	2SC945 Q, P, K	1D				
TR25	0305951 ~ 3	2SC945 Q, P, K	1D				
TR26	0305951 ~ 3	2SC945 Q, P, K	1D				
TR27	0305951 ~ 3	2SC945 Q, P, K	1D				
TR28	0305951 ~ 3	2SC945 Q, P, K	1D				
TR29	0305951 ~ 3	2SC945 Q, P, K	1D				
TR30	0305951 ~ 3	2SC945 Q, P, K	1D				
TR31	0305951 ~ 3	2SC945 Q, P, K	1D				
TR32	0305951 ~ 3	2SC945 Q, P, K	1D				
TR33	0305951 ~ 3	2SC945 Q, P, K	1D				
TR34	0305951 ~ 3	2SC711 E, F, G	1A				
TR35	0305951 ~ 3	2SC711 E, F, G	1A				
TR36	0305951 ~ 3	2SC945 Q, P, K	1C				
TR37	0305951 ~ 3	2SC945 Q, P, K	1C				

3-4. F-2876 Power Supply Circuit Board (Stock No. 7503401)

Conductor Side

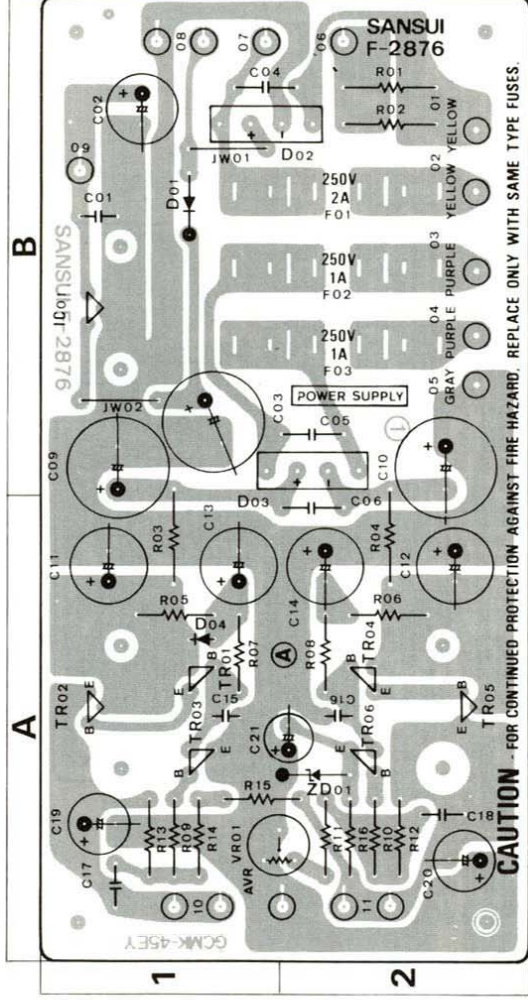

Parts List

Parts No.	Stock No.	Description	Position
● Transistor			
TR01	0306070 ~ 2	2SC1313 F, G, H	1A
TR02	0308391 ~ 3	2SD313AL D, E, F	1A
TR03	0306070 ~ 2	2SC1313 F, G, H	1A
TR04	0300510, 1	2SA733A P, Q	2A
TR05	0303231 ~ 3	2SB507V11-AL D, E, F	2A
TR06	0300510, 1	2SA733A P, Q	2A
● IC			
IC 01	0360920	FS7805M	1B
● Diode			
D 01	0310340	10D1	1B
D 02	0311700	RB-152	1, 2B
D 03	0311700	RB-152	1A
D 04	0310340	10D1	1A
● Zener Diode			
ZD01	0315770	EOA01-06S	2A
C 04	0655103	1000pF 500V C.C.	1, 2B
C 05	0655103	1000pF 500V C.C.	2B
C 06	0655103	1000pF 500V C.C.	2A
C 15	0622471	470pF 125V P.C.	1A
C 16	0622471	470pF 125V P.C.	2A
R 01	0211479	4.7Ω 1W N.I.R.	2B
R 02	0211569	5.6Ω 1W N.I.R.	2B
R 03	0211100	10Ω 1W N.I.R.	1A
R 04	0211100	10Ω 1W N.I.R.	2A
VR01	1035110	4.7kΩ B DC Voltage Adjust	1, 2A
F 01	0432240	2A 250V AC Fuse	2B
F 02	0432240	1A 250V AC Fuse	2B
F 03	0432220	1A 250V AC Fuse	2B

3-5. F-2875 Buffer Amp. Circuit Board (Stock No. 7597911)

Conductor Side

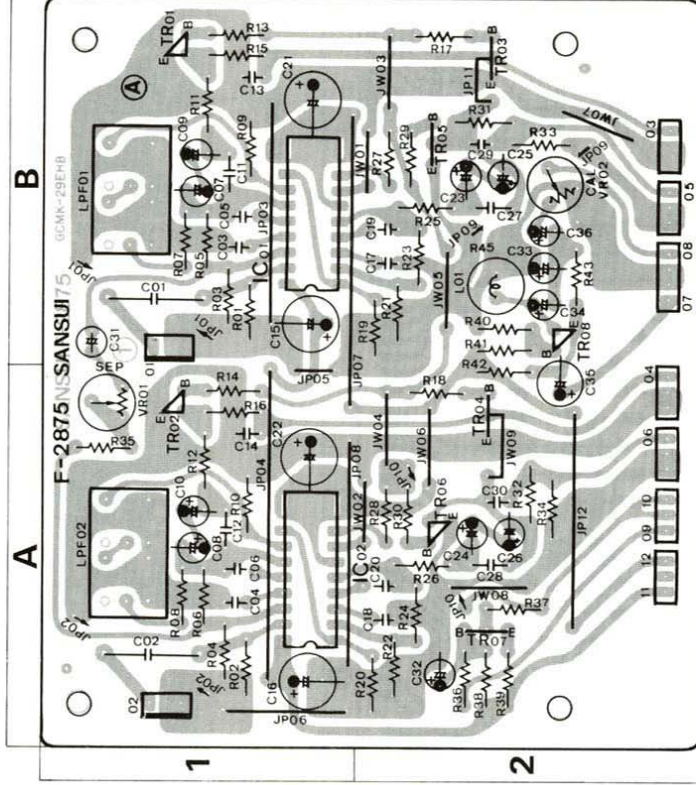

Parts List

Parts No.	Stock No.	Description	Position
● Transistor			
TR05, 06	0305951 ~ 3	2SC945 O, P, K	2B, 2A
TR07	0300510, 1	2SA733A P, Q	2A
TR08	0306010, 1	2SC1222 (2) U, E	2B
● IC			
IC 01, 02	0360810	UPC1190C	1B, 1A
C 01, 02	0602109	1.0μF 100W F.C.	1B
C 03, 04	0622101	100pF 125V P.C.	1B, 1A
C 05, 06	0623220	22pF 125V P.C.	1B, 1A
C 17, 18	0622101	100pF 125V P.C.	2B, 2A
C 19, 20	0623220	22pF 125V P.C.	2B, 2A
C 32	0585229	2.2μF 50V E.C.	2A
C 33	0585339	3.3μF 50V E.C.	2B
C 34	0585339	3.3μF 50V E.C.	2B
L 01	4900220	100mH Inductor	2B
LF 01, 02	0910540	Low Pass Filter	1A, B
VR01	1035230	470kΩ B Separation Volume	1A
VR02	1035190	100kΩ B Cull-ration Trne Volume	2B

- The circuit boards, F-2872 are not supplied as the assembled, the individual part on the circuit boards, however are provided for orders.

3-6. F-2872 AM, FM Band Width Switch Circuit Board

Conductor Side

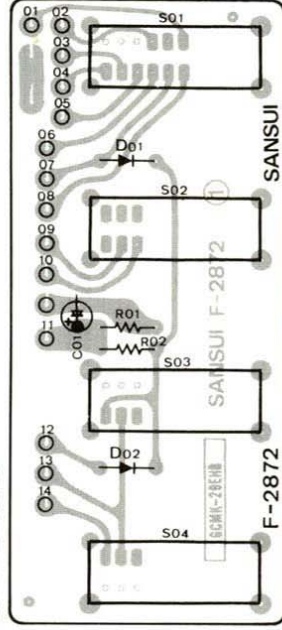

Parts List

Parts No.	Stock No.	Description
● Diode		
D 01	0311160	1S2473D
	0311180	1S1588
D 02	0311160	1S2473D
	0311180	1S1588
S 01	1172070	AM Band Width Switch
S 02	1171130	FM Band Width Switch
S 03	1171130	Muting Switch
S 04	1171130	Auto Noise Filter Switch

● Abbreviations

C.R.	Carbon Resistor	E.L.	Low Leak Electrolytic Capacitor
S.R.	Solid Resistor	E.B.	Bi-Polar Electrolytic Capacitor
Ca.R.	Cement Resistor	E.BL.	Low Leak Bi-Polar Electrolytic Capacitor
M.R.	Metal Film Resistor	Ta.C.	Tantalum Capacitor
F.R.	Fusing Resistor	F.C.	Film Capacitor
N.I.R.	Non-Inflammable Resistor	M.P.	Metalized Paper Capacitor
C.C.	Ceramic Capacitor	P.C.	Polystyrene Capacitor
C.T.	Compensation Electrolytic Capacitor	G.C.	Gimmic Capacitor
E.C.	Electrolytic Capacitor		

4. OTHER PARTS

4-1. Front View

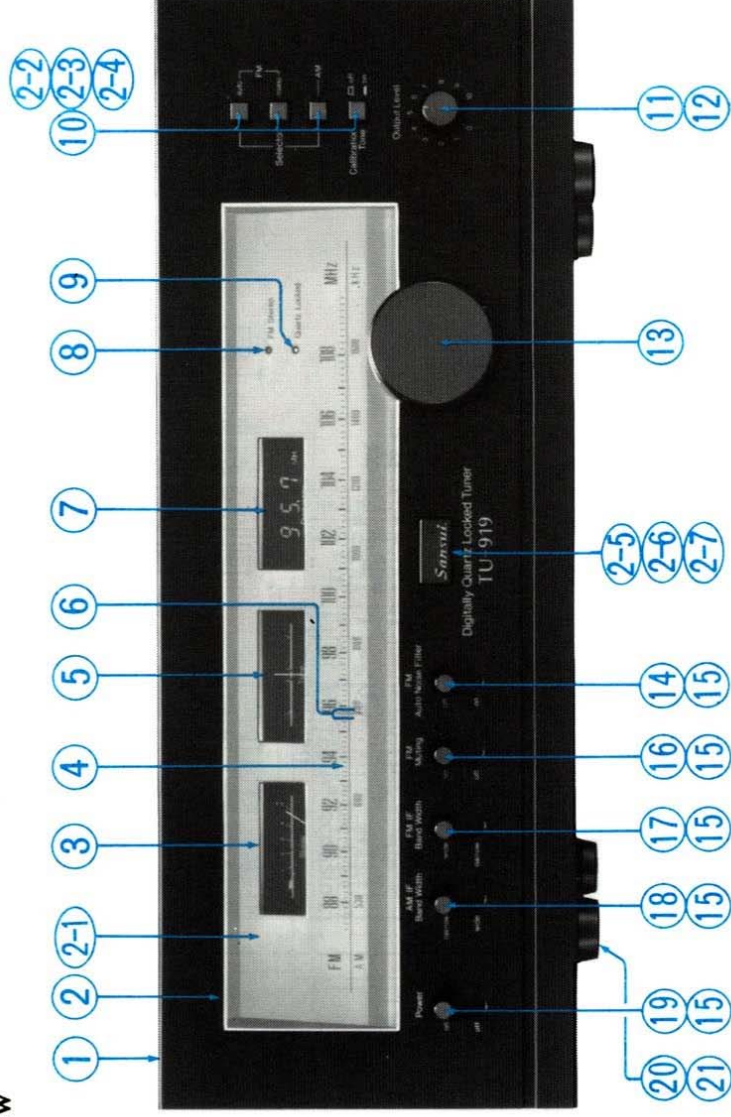

Parts List <Front View>

Parts No.	Stock No.	Description
1	500685Q	Bonnet
2	7008111	Front Panel Ass'y
2-1	5446640	Dial Window
2-2	5326620	Push Knob
2-3	5286721	Knob Guide
2-4	6906480	Spring
2-5	5336600	Sansui Badge
2-6	5152210	CS Ring, Sansui badge
2-7	5507050	Packing
3	4301370, 1	300µA 650Ω, signal meter
4	5408390	Dial Scale
5	4301380, 1	150µA 650Ω, tune meter
6	5416463	Dial Pointer
7	0319220	LED, display unit
8	0319060	LED (red), FM stereo
9	0319050	LED (green), quartz locked
10	1132010	Selector & Calibration Switch
11	1015480	Level Volume, 10kΩ B x 2
12	5819260	Knob, level volume
13	5318903	Knob, tuning
14	1171130	Auto Noise Filter Switch
15	5326612	Knob, lever switch
16	1171130	FM Muting Switch
17	1171130	FM IF Band Width Switch
18	1172070	AM IF Band Width Switch
19	1171630	Power Switch
20	5066322	Bottom Cover
21	5507350	Leg

Parts List <Top&Bottom View>

Parts No.	Stock No.	Description
C 701	0622682	6800pF 125V P.C.
C 702	0659801	0.01µF 150V C.C.
C 703	0659802	0.0047µF 150V C.C.
PT 702	4003080	Power Transformer
T 701	4290023	FM Balun
T 702	4201000	AM Bar Antenna
PL 701, 702	0400720	8V 300mA, pilot lamp
F 701	0432210	AC Fuse 0.5A 250V
	0432220	AC Fuse 1A 250V
	2410091	Voltage Selector, plug
	2410830	Voltage Selector, socket
	2300060	AC Fuse Holder
	2200290	1P AM IF Output Terminal Board
A	2200560	2P FM Multipath Terminal Board
B	2200580	4P Output Terminal Board
C	2210360	4P Antenna Terminal Board
	2450070	AC Outlet
	7136091	Tension Unit
	7036650	Tuning Unit
	2440031	FM 75Ω Antenna Terminal
	3800470, 1	Power Cord
	3910510	Strain Relief, power cord
	5286450	Bar Antenna Holder (A)
	5286480	Bar Antenna Holder (B)
	9910600	Strain Relief, bar antenna cord
	6146722	Pulley
	7510731	Front-end Pack, FR814U12

4-2. Top View

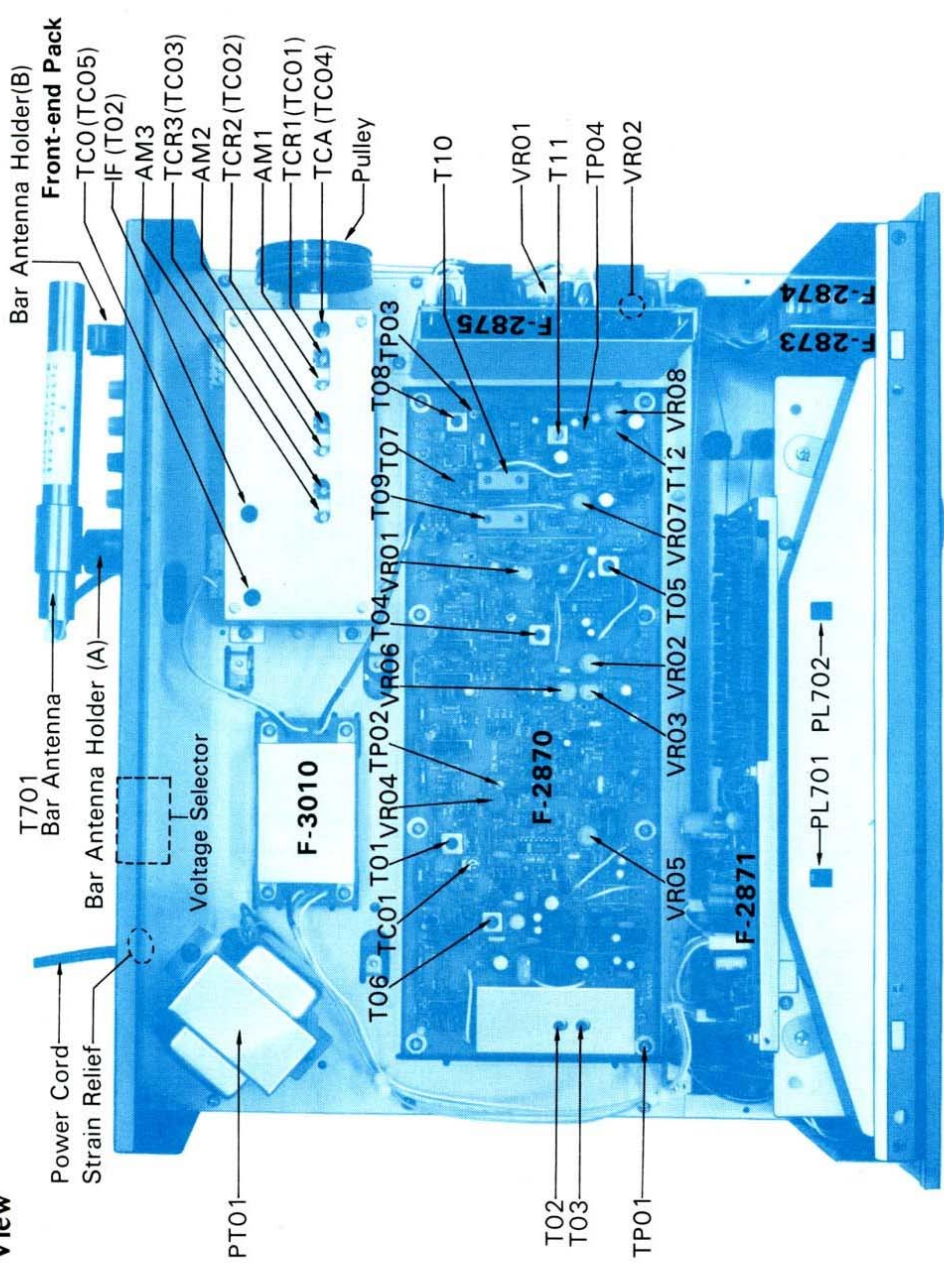

4-3. Bottom View

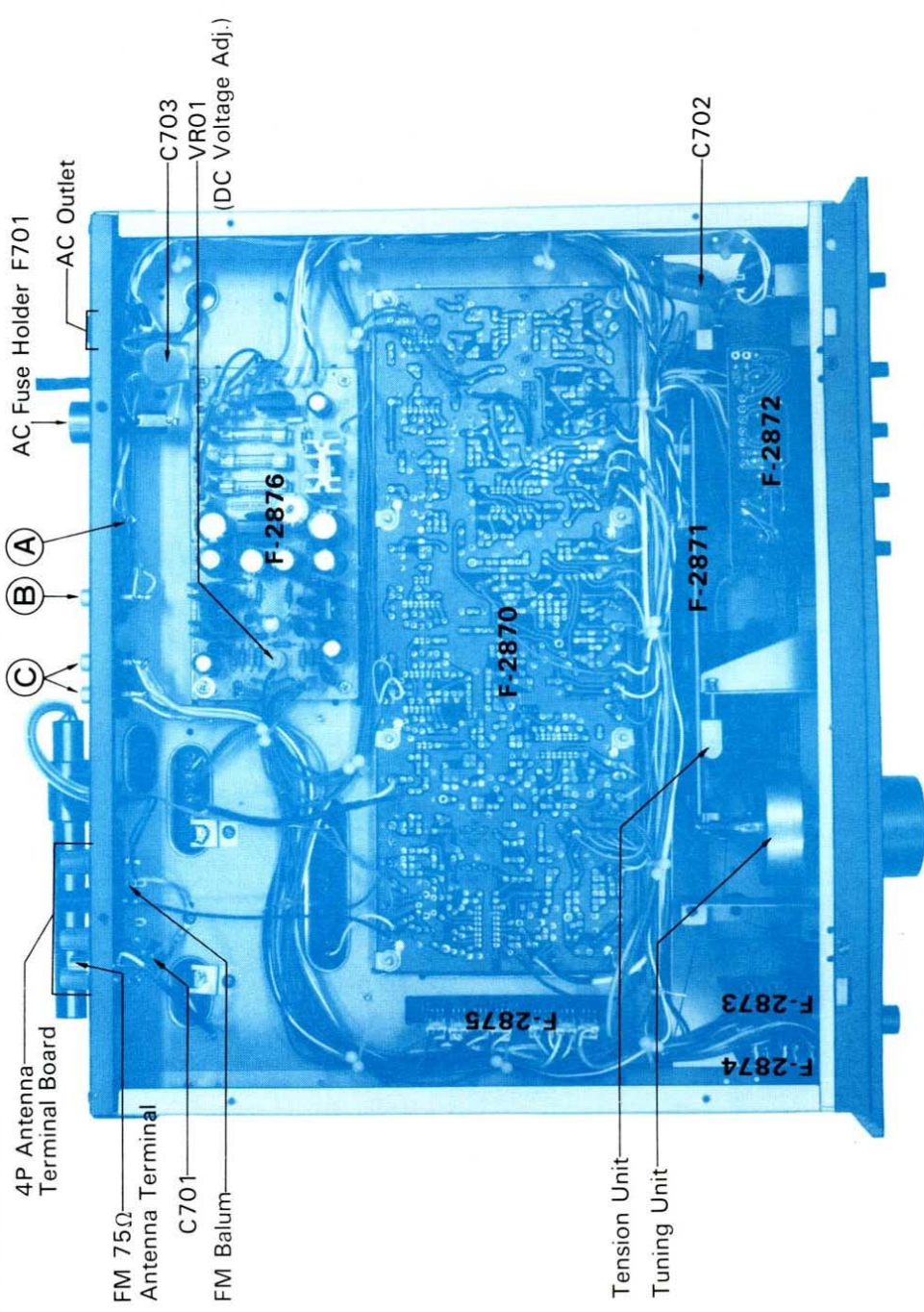

5. SCHEMATIC DIAGRAM 5-1. Tuner Section

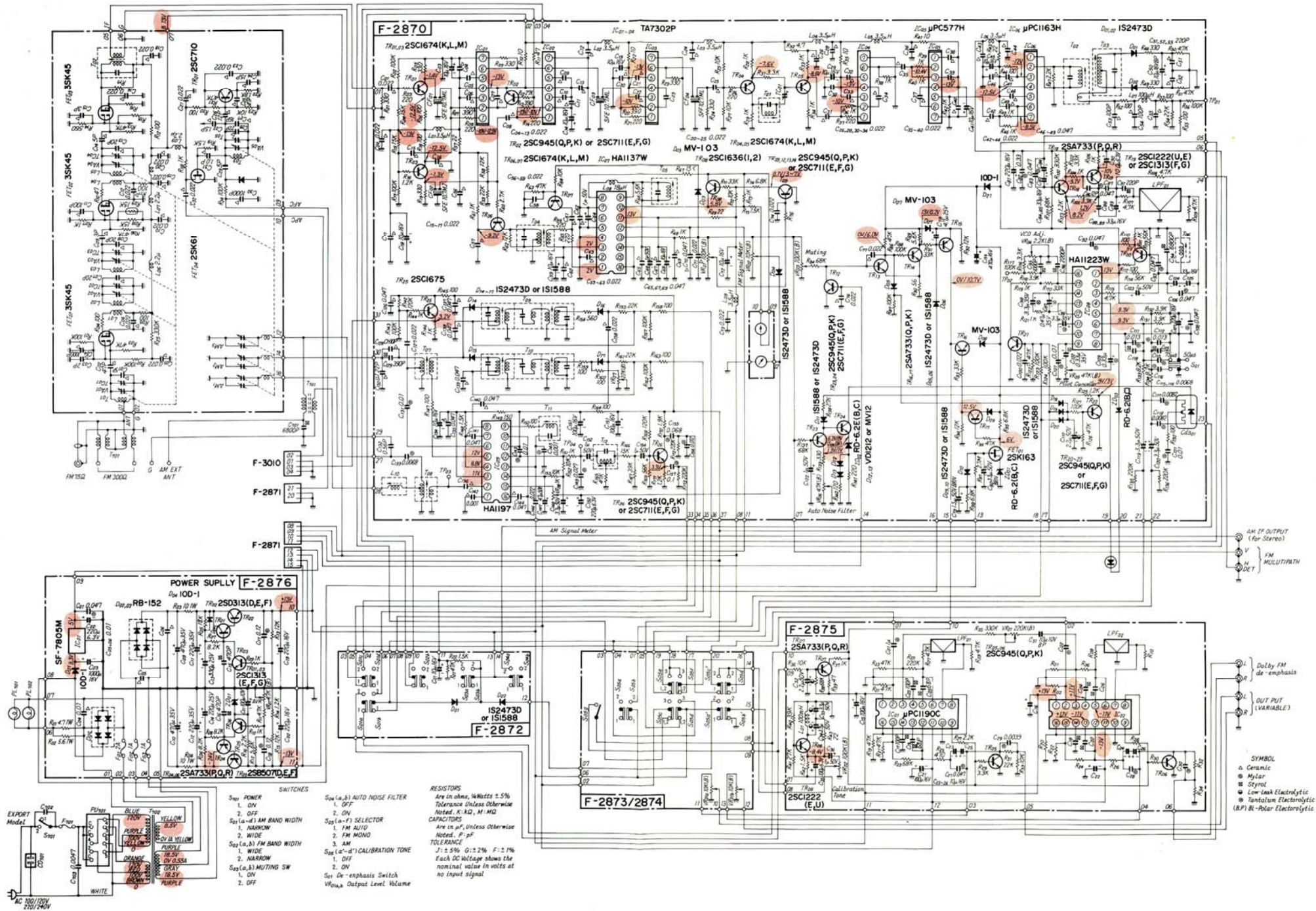

6. THREADING OF DIAL CORD

- If a dial cord is cut off or slips, replace it by following procedures. As this unit uses 0.5 mmφ cord, please replace it with the same type certainly.
- The length of dial cord is approximately 240 cm (98.4 inch).

6-1. Threading of Dial Cord

Thread the dial cord in numerical order from ① to ⑰ as Fig. 1.

- Open the variable capacitor completely.
- * Dial Cord (0.5 mmφ) (Stock No. 6036051)

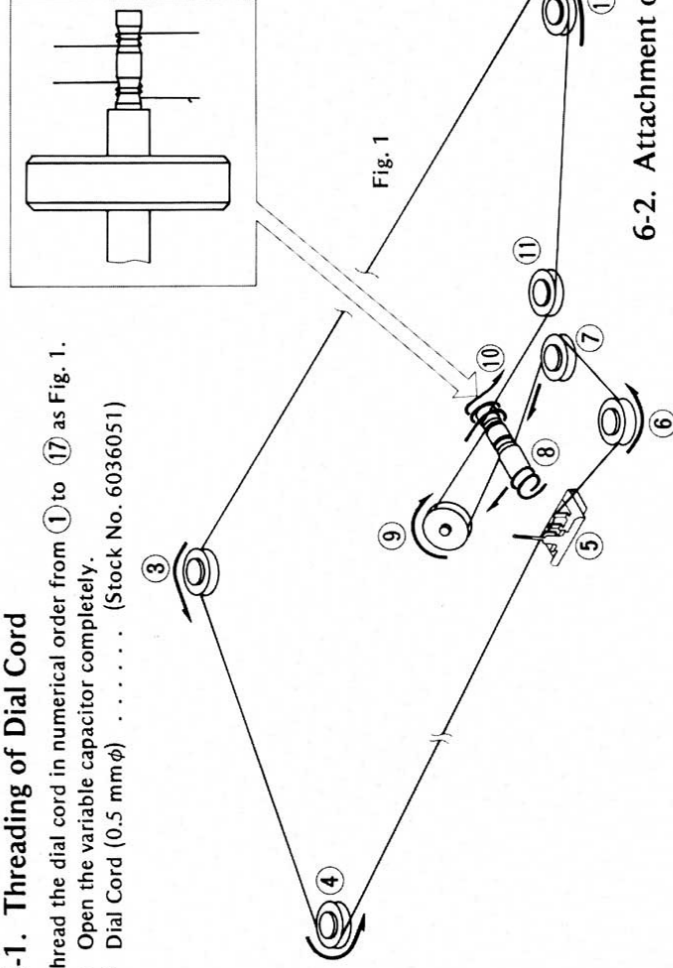

6-2. Attachment of Dial Pointer

1. After installing the dial string, turn on the power switch. If the digital display is in the "FM Reception" state, turn the tuning knob until the digital display indicates 98.0 MHz. Then, fix the pointer to the dial string, after setting the pointer to the 98.0 MHz value of the scale.
2. After attaching Dial pointer, confirm Dial pointer moves from 88 MHz to 108 MHz to turn the tuning knob.

7. PACKING LIST

Parts No.	Stock No.	Description
1	9116790	Vinyl Cover
2	9028320	Styrofoam Packing
3	9001621	Carton Case

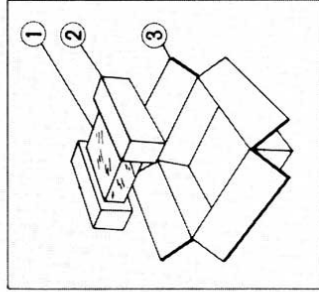

8. ACCESSORY PARTS LIST

Stock No.	Description
3820120	FM Antenna
9203840	Operating Instructions
3810320, 1	Pinplug Cord
2440021	F Type Connector,
	FM 75Ω antenna
5396720	Rec mounting Adaptor (ea)
9237890	Schematic Diagram

Sansui

SANSUI ELECTRONICS CORPORATION: 1250 Valley Brook Ave. Lyndhurst, N.J. 07071 U.S.A.
333 West Alondra Blvd. Gardena, California 90247 U.S.A.

SANSUI AUDIO EUROPE N.V.: 3036 Koopaka St. Honolulu, Hawaii 96819 U.S.A.
SNASUI AUDIO EUROPE S.A.: North Trade Bldg (9th floor) Noorderlaan 133-Bus 1, 2030 Antwerp, Belgium
Arabella center, 6 Frankfurt AM Main, Lyoner Strasse 44-48, West Germany
SANSUI ELECTRIC COMPANY LTD.: 14-1, Izumi 2-chome, Suginamiku, Tokyo 168 Japan PHONE: (03) 323-1111/TELEX: 232-2076

SM131

Printed in Japan (697230M)